

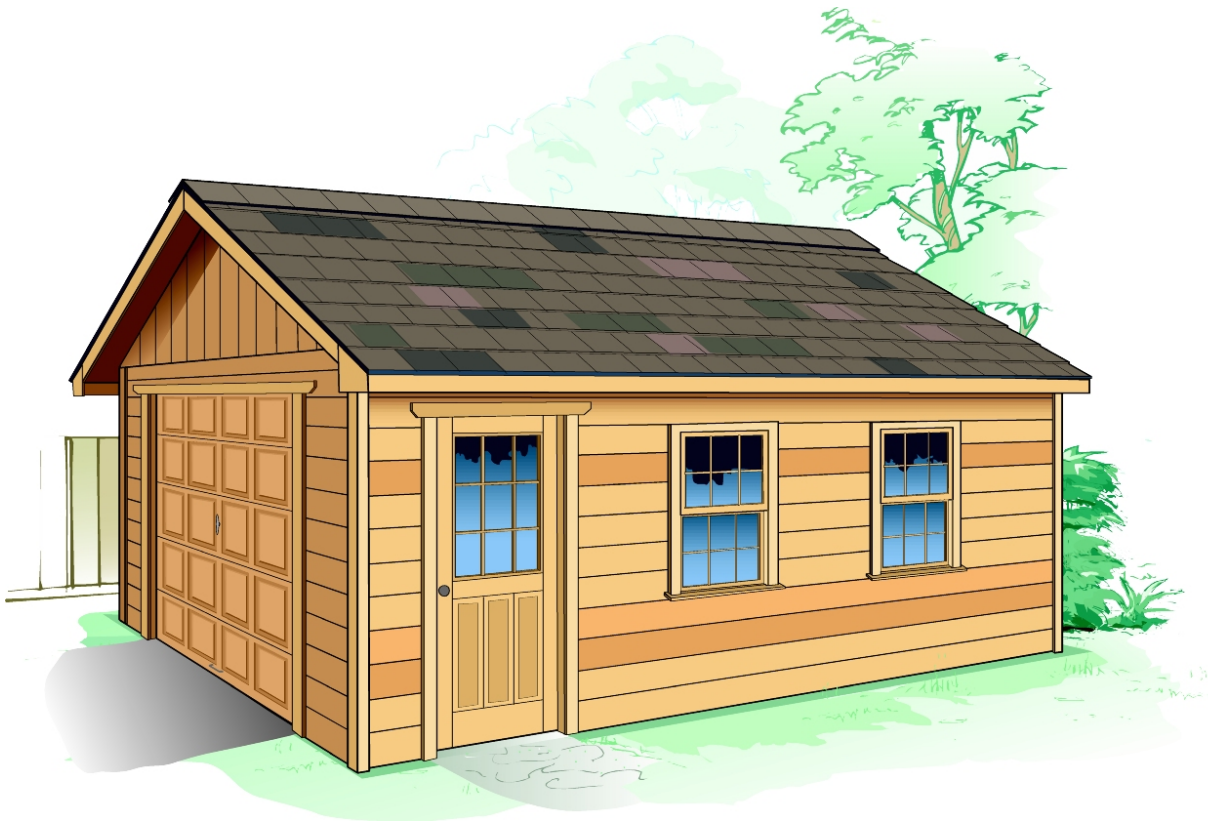

# HIGHLANDS GARAGE

## Specifications & Construction Details



**V.1.0**

Summerwood Products  
Contact Us: 1.800.663.5042 or [design@summerwood.com](mailto:design@summerwood.com)  
©2006 [www.summerwood.com](http://www.summerwood.com)

## TABLE OF CONTENTS

<b><i>Introduction</i></b>		3
<b>1. Material Specification Charts</b>		4
<b>2. Dimensions</b>	2.1 Elevations	5
	2.2 Plan (Footprint)	6
<b>3. Construction Details</b>	3.1 Foundations	7
	3.2 Walls	8
	3.3 Roofs	10
	3.4 Trim & Finishing	11
<b>4. Available Material Upgrades</b>	4.1 Cedar Stud Framing	12
	4.2 Cedar Roof Framing	12
	4.3 Cedar Roof Boards	12
	4.4 Interior Cedar Wallboards	13
	4.5 Other Options	13
<b>5. Available Garage Options</b>	5.1 Windows & Doors	14
	5.2 Cedar Shingles	15
	5.3 Interior Walls	15
	5.4 Other Options	15
<b>6. Additional Information</b>	6.1 Floor Plans	16
	6.2 Electrical Considerations	17
	6.3 Plumbing Considerations	17
	6.4 Interior Insulation	17

---

## *INTRODUCTION*

The following pages explain everything you need to know about our Highlands Garage.

If you have already purchased a Highlands, thank you for choosing this outstanding product. This booklet will provide additional details about the construction process, as well as information that will help you maximize the use of your new Highlands Garage.

If you are considering a Highlands Garage purchase, this document will help you make an educated choice by outlining all its technical (and not so technical) details.

### Garage Features:

- All our garages are built to meet or exceed rigorous North American building codes.
- They are delivered pre-cut or pre-assembled depending on your preference.
- We also provide all the required nails and hardware.
- They are available in many sizes, and are fully customizable to meet your individual style.
- Your choice of Canadian western red cedar siding or Canexel maintenance-free siding (in your choice of 14 colors).
- Your choice from a wide selection of beautifully crafted windows and doors, including thermal and tempered options.
- 8' wall height.

Expect nothing but the best when you purchase a Summerwood structure. We use quality materials and have in place excellent quality control systems. For added piece of mind, your garage is covered by a five-year warranty for defects in materials and workmanship.

If you have any questions about our signature Highlands Garage or the information contained in this booklet, please contact one of our Design Specialists:

<b>ASK A DESIGN SPECIALIST</b>
<b>Call: 1.800.663.5042</b>
<b>Email: <a href="mailto:design@summerwood.com">design@summerwood.com</a></b>

## 1. MATERIAL SPECIFICATIONS CHARTS

The following charts provide an overview of the parts and materials we use in our garages.

### Abbreviations Legend

O/C - On centers

PT - Pressure treated (lumber)

OSB - Oriented strand board

SPF - Spruce/Pine/Fir

### FLOOR (Not Provided)

Garages must utilize a concrete foundation flooring in order to meet building code requirements.

More guidance available online at [www.summerwood.com](http://www.summerwood.com) under 'Construction Details'.

### WALLS

Item	Material	Dimension	Grade	Spacing	Notes
Bottom Plates	Spruce	2 x 6	2	N/A	Pressure Treated
Studs	Spruce	2 x 6	2	Every 16" O/C	Heights may vary
Top Plates	Spruce	2 x 6	2	N/A	Ties studs
Double Top Plates	Spruce	2 x 6	2	N/A	Support in corners
Wall Sheathing	OSB	4' x 8' x 7/16"	0 - 2	Entire walls	Rated 24/16 - roof/walls
Weather Membrane	Tyvar	8"	Type 1	Covers walls	Prevents moisture
Siding Option 1	Cedar	3/4" x 8"	2	None	Lap board cut
Siding Option 2	Canoxel	3/8" x 12"	1	None	Tongue and groove
Fasteners	Steel Nails	3"	Galvanized	Every 2"	Used in wall framing
Fasteners	Steel Nails	2"	Galvanized	Every 8"	Secures strapping and siding
Fasteners	Steel Staples	1/2"	N/A	Every 8"	Used to secure membrane

### ROOF

Item	Material	Dimension	Grade	Spacing	Notes
Ceiling Joist	Spruce	Varies on size.	2 SPF	24" O/C	Supports loft space
Rafters	Spruce	Varies on size.	2 SPF	24" O/C	30-degree (7/12) pitch
Side Supports	Spruce	Varies on size.	2 SPF	N/A	Secured by gusset
Peak Support	Spruce	Varies on size.	2 SPF	N/A	Secured by gusset
Roof Boards	Plywood	1/2"	0 - 2	Entire roof	H-clips on seams
Gussets	Plywood	5/8"	N/A	Every joint	Glued and nailed
Ridge Blocking	Spruce	2 x 6	2 SPF	N/A	Support between truss

### TRIM

Item	Material	Dimension	Grade	Notes
Skirts	Cedar	1 x 6	1	One course included; covers floor material
Corners	Cedar	1 x 6	1	Cut down to 4"
Soffits	Cedar	1 x 6	1	Two rows make up soffits
Fascia	Cedar	1 x 6	1	Covers truss ends
Windows	Cedar	1 x 6	1	Cut down to 2 1/2" for outer trim
Doors	Cedar	1 x 6 & 2 x 4	1	1 x 6 trim and 2 x 4 jambs

Summerwood Products

Contact Us: 1.800.663.5042 or [design@summerwood.com](mailto:design@summerwood.com)

## 2. DIMENSIONS

### 2.1 Elevations

The following charts and corresponding diagrams provide important details about the elevation dimensions and perimeter measurements for your particular garage. Truss sizes can vary slightly, due to shipping & manufacturing concerns.

The dimensions in *Figure 2.1a* are accurate, however, some variances may occur. Wood is a natural construction material and as a result may vary with settling. The measurements below do not account for roofing materials, such as roof boards and shingles.

**Figure 2.1a: Front and Roof Elevation** (Soffit Overhang is 12")

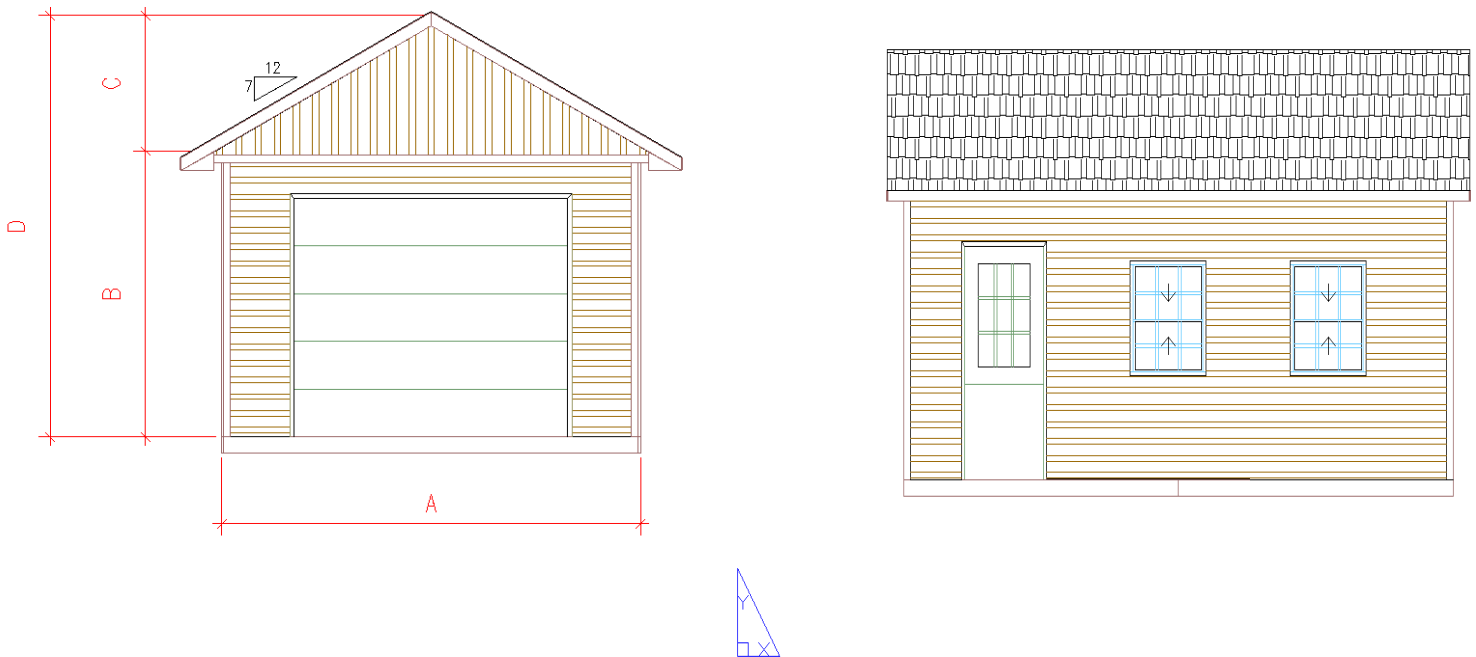

A Building Depth	B Wall Height	C Roof Height	D Overall Height
12'	8' 4 1/2"	48 1/2"	13' 1/2"
14'	8' 4 1/2"	55"	13' 7"
16'	8' 4 1/2"	66"	14' 8"
18'	8' 4 1/2"	73"	15' 3"

## 2.2 Plan (Footprint)

Use the measurements in *Figure 2.2a* to determine the location and placement of your garage. We also provide exact dimensions, which helps uncover potential layouts and uses. You can find many examples of potential layouts for your garage at <http://www.summerwood.com/>

**Figure 2.2a: Footprint Chart**

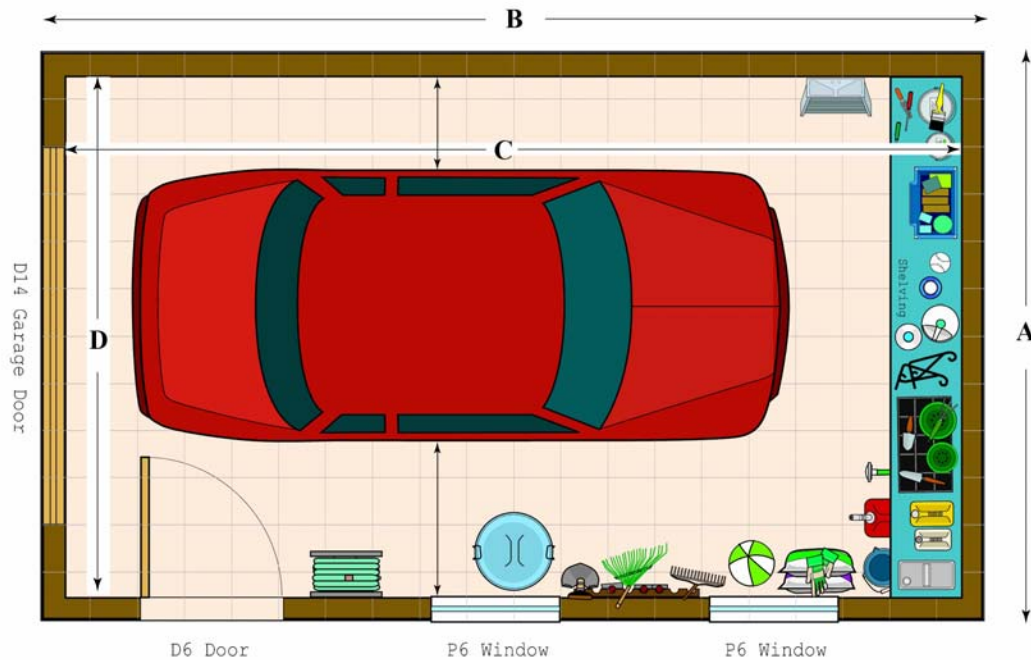

Depth	Width	Interior Length	Interior Width
<b>A</b>	<b>B</b>	<b>C</b>	<b>D</b>
12'	12'	133"	133"
12'	14'	157"	133"
12'	16'	181"	133"
14'	14'	157"	157"
14'	16'	181"	157"
14'	18'	205"	157"
16'	16'	181"	181"
16'	18'	205"	181"
16'	20'	229"	181"

## 3. CONSTRUCTION DETAILS

### 3.1 Foundation

It is always advisable to consult a local foundation expert when considering the installation of your garage. It is important to know your area's building codes and there may be other considerations as well. We've included a sample of the most popular foundation choice (Concrete Pads) but please remember that foundation options are not limited to only this one.

#### Concrete Pad Features:

- Offers Superior support
- Eliminates the need for framed floors
- For those who prefer, concrete pads can still be used with a framed floor to provide the best overall support

Please note that Concrete pad requirements vary more than other foundations. For more information, check with your local area's building codes.

*Figure 3.1: Foundation Options*

**a. Footings Below Grade**

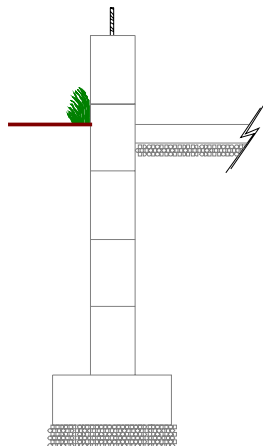

**b. Pad On Grade**

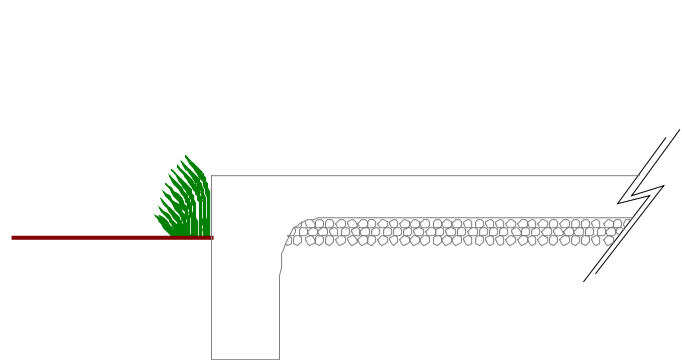

## 3.2 Walls

All of our garages feature 2 x 6 spruce/pine/fir wall framing lumber (wall studs), which are centered at 16-inch intervals. Exterior insulation is included, which is required if you will be insulating the interior of your garage.

Exterior insulation (*see Figure 2.2a*) consists of a base OSB (i.e. oriented strand board) wallboard nailed every 8 to 12 inches. Once your garage has been sheathed (OSB that has been nailed to the framing), a tyvar weather membrane is wrapped around the entire building. Any required openings are then cut out.

Depending on your siding choice, we may supply a breather material used to provide airflow between your siding and membrane to prevent moisture buildup. The siding is then nailed into place using high quality fasteners.

**Figure 3.2a: Enhanced Siding Upgrade**

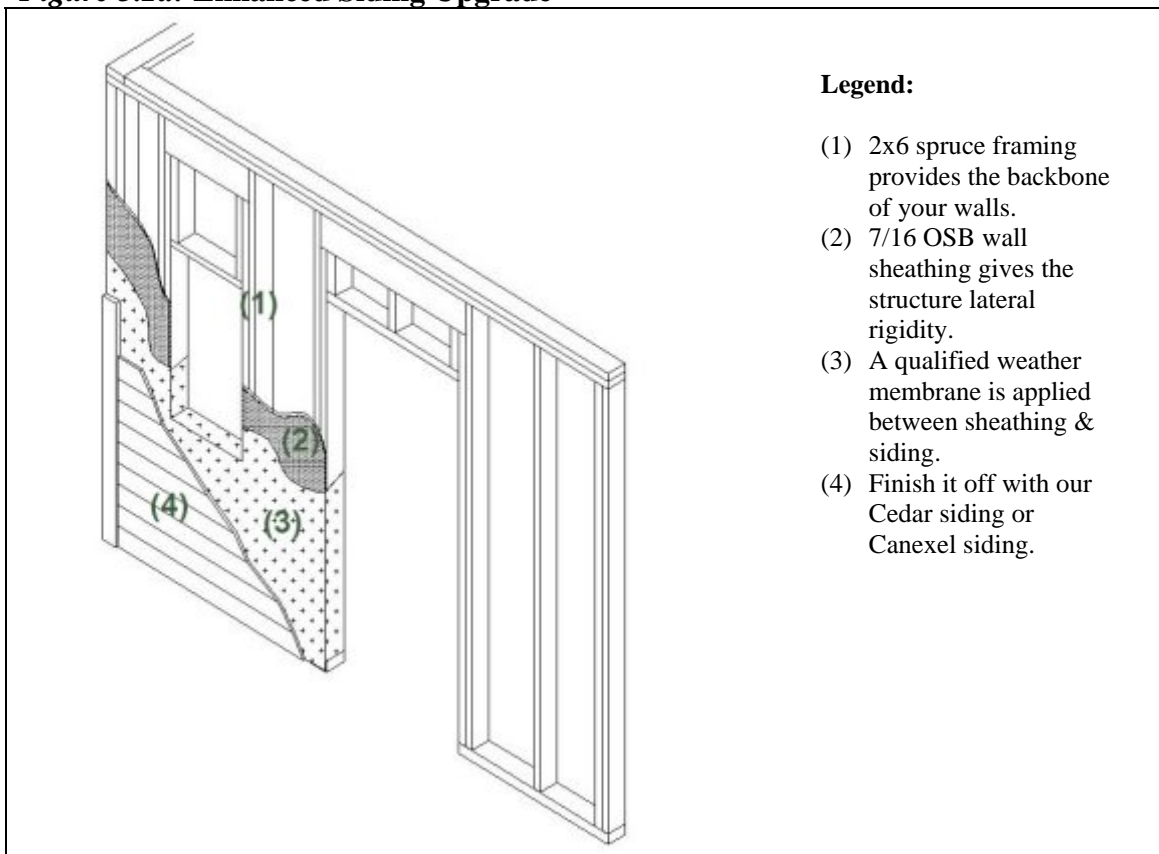

## 3.2 Walls con't.

Where possible, we accommodate the largest headers – lintels – that room allows. These support beams are framed in (built directly into the walls) above doors and windows. All of these features – headers, support beams, doors and windows – are built to exceed most North American buildings codes.

Should building code restrictions or requirements force an alternative solution, inform us and we will do our best to accommodate your needs.

**Figure 3.2b: Header Detail**

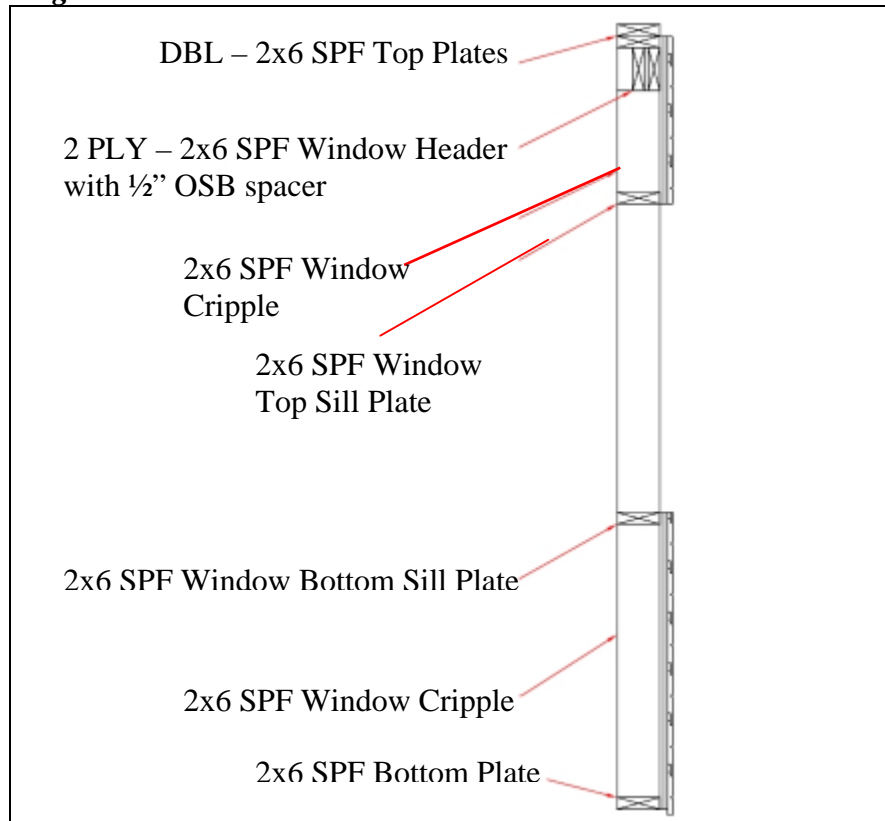

### 3.3 Roofs

Our garages are designed to be versatile and meet needs beyond simply storing your car. The loft space above the garage is ideal for storage or possibly additional sleeping quarters. The chart below highlights some of the distinctive characteristics of our garage roof.

**Please note:** Some trusses are simply longer than the conventional trucks available to ship them. When this happens, we will order and arrange delivery of trusses from local suppliers in your area. Due to this factor, loft spaces may vary from the below given dimensions.

**Table 3.3a: Loft Dimensions**

Size	Loft Space	Overall Height	Material
12 x 12	7' x 2½' x 12'	48"	2 x 6 SPF
12 x 14	7' x 2½' x 14'	48"	2 x 6 SPF
12 x 16	7' x 2½' x 16'	48"	2 x 6 SPF
14 x 14	90" x 30" x 14'	54"	2 x 6 & 2 x 8 SPF
14 x 16	90" x 30" x 16'	54"	2 x 6 & 2 x 8 SPF
14 x 18	90" x 30" x 18'	54"	2 x 6 & 2 x 8 SPF
16 x 16	96" x 48" x 16'	66"	2 x 6 & 2 x 8 SPF
16 x 18	96" x 48" x 16'	66"	2 x 6 & 2 x 8 SPF
16 x 20	96" x 48" x 16'	66"	2 x 6 & 2 x 8 SPF

Our roofs provide a 12-inch overhang on the back and front, while the side overhangs 6". Roof board materials consist of ½-inch plywood with H-clips, which we supply; together, they provide support between your roof boards. The H-clips provide additional support in cases where the roof boards do not meet on the trusses.

Depending on your choice of shingles, there are different methods you can use to finish your roof. Consider purchasing a roofing membrane at your local building supply outlet. The type of membrane you choose will depend on the weather conditions in your area. To ensure rigid roof assembly, we provide truss blocking.

**Figure 3.3b: Typical Truss design**

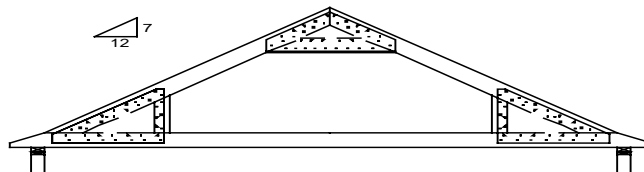

### 3.4 Trim & Finishing

All of our trim consists of premium western red cedar, dressed on all four sides for a clean, flat and smooth finish with few knots. The following list highlights the special trim and finishing qualities featured on our garages. *Table 3.4a* provides illustrated detail for each component.

**Table 3.4a: Trim & Finishing**

<b>Skirts (T4 &amp; T5)</b>	Our garages come with one course of skirts. Skirts are fastened to the lower walls to cover the pad.
<b>Corners (T1 &amp; T2)</b>	Corners provide protection from the weather on the siding end-grains. Finished corners also give your garage a uniform look. Corner trim runs from the base to the soffits.
<b>Gable (T3)</b>	The gable hides the joint between the truss and wall sections. To ensure a weather-tight seal, we recommend applying a bead of silicone to the back.
<b>Soffits (T6 &amp; T8)</b>	Soffits are secured to the underside of your overhang. We also include vents to help provide airflow and prevent moisture build-up in the roof.
<b>Fascia (T7 &amp; T9)</b>	The fascia finishes the truss ends for a uniform look.
<b>Door &amp; Window</b>	Both are caulked to protect against weather.

**Figure 3.4a: Material Detail**

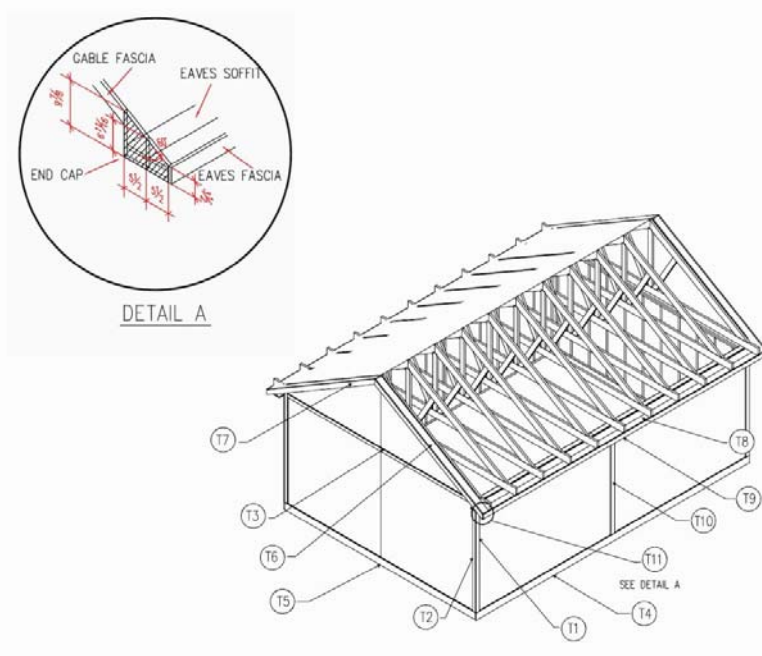

Summerwood Products  
 Contact Us: 1.800.663.5042 or [design@summerwood.com](mailto:design@summerwood.com)  
 ©2005 [www.summerwood.com](http://www.summerwood.com)

---

## 4. AVAILABLE MATERIAL UPGRADES

We offer endless possibilities that add something special to make your Summerwood structure unique. In this section, we demonstrate some of the available upgrades that may be applied to your Garage.

Please keep in mind that we provide many choices and upgrades. For a complete look at all we have to offer, visit [www.summerwood.com](http://www.summerwood.com). Or contact a Design Specialist to find out more: 1.800.663.5042 or [design@summerwood.com](mailto:design@summerwood.com).

### 4.1 Cedar Stud Framing



Consider leaving the interior of your garage exposed and upgrade to cedar stud framing. Give your garage that distinctive look, fragrant smell, and old fashioned feeling that can only come from western red cedar.

### 4.2 Cedar Roof Framing

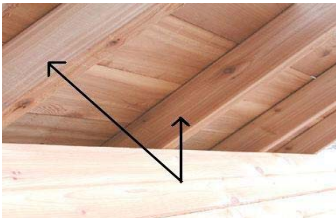

Add “old style” charm to your garage with a cedar roof framing upgrade. Give your garage a rich and beautiful look by upgrading to cedar framing from the spruce.

### 4.3 Cedar Roof Boards

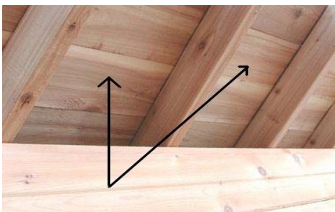

Take advantage of cedar’s exceptional beauty and quality by upgrading your OSB roof boards to premium cedar 1 x 6 roofing.



Dress up the interior of your garage with our wallboard package. Cover up the studs and interior fittings to give your garage a beautiful cedar finish -- inside and out.

### 4.5 Other Options

We offer a litany of other interior options that will help your garage reach its full potential. Upgraded trusses, reinforced wall studs, cedar ceilings. The list is almost endless and so are the possibilities. Visit the 'Options section' at [www.summerwood.com](http://www.summerwood.com) and find out more!

---

## 5. AVAILABLE GARAGE OPTIONS

### 5.1 Doors & Windows

Our Garage doors and windows are handmade by our skilled workers right here in North America. We can customize your selections to meet your requirements. Do you have a specific window size or placement requirement? Perhaps you prefer tempered glass to keep heat in? These are just a few of the standards our designers can meet. Whatever your criteria, we go above and beyond to satisfy even the most discerning of homeowners.



Below is a small selection of the garage doors we offer; for more details visit [www.summerwood.com](http://www.summerwood.com)

### Sample garage doors:



## 5.2 Cedar Shingles

Top off your garage with quality, long lasting, naturally weather resistant cedar shingles. You can either stain or finish your shingles, or simply let them age gracefully for a distinguished look.



## 5.3 Interior Walls

Whether you choose to use your product as a garage, a furnace room or just extra storage space (or a combination of other uses), we can accommodate nearly any request and divide up your space using interior walls. We use the same quality cedar channel you will find on the exterior of our structure.



## 5.4. Other Options

We offer a litany of other options that will help your garage reach its full potential. We offer benches, shelving, lighting, shower adaptations... really too many to even consider listing here. To see a complete list, visit the 'Options section' of [www.summerwood.com](http://www.summerwood.com).

## 6. ADDITIONAL INFORMATION

### 6.1 Floor Plans

The following Floor Plan examples demonstrate how some of our garage customers have utilized these spaces. Partition walls and their exact placement can be discussed with your Design Specialist. ‘Blank’ floor plans can also be found online.

All sizes of Garage Floor plans are available online, and we can also prepare a 3D virtual drawing of both the interior and the exterior at you request and for a small additional cost.

We can accommodate nearly every idea or concept you may have so you can get the most out of your Summerwood garage. Contact us at 1.800.663.5042 or [design@summerwood.com](mailto:design@summerwood.com) for more details.

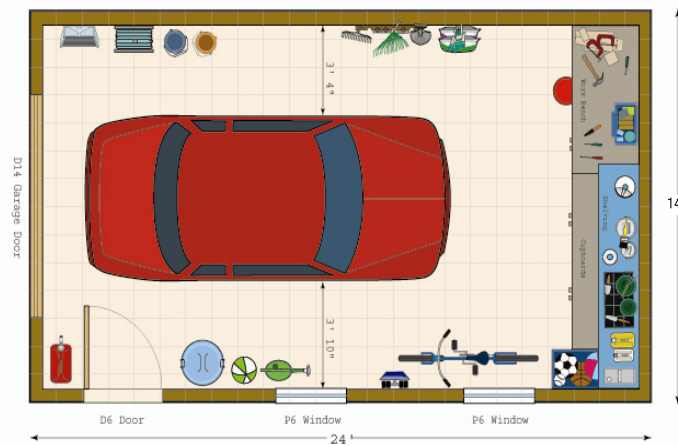

*Example: 14' x 24' Highlands Garage.*

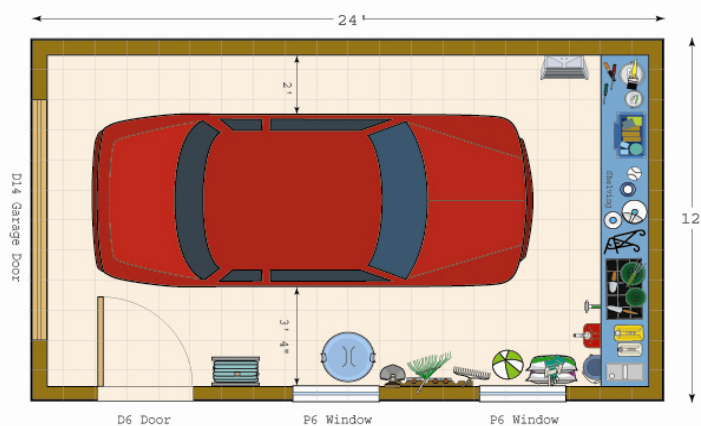

*Example: 12' x 24' Highlands Garage.*

## 6.2 Electrical Considerations



The inside of our garages are deliberately left exposed to accommodate various electrical applications. Whether you intend to light the inside or install a decorative ceiling fan, we provide the flexibility for you to choose the most suitable option.

Main electrical connections are generally buried in the ground or passed through the air via suspended power lines. Contact an experienced professional to prepare your main connection, interior wiring and any other electrical needs. If you have a specific electrical requirement you wish to accommodate, please inform your design expert of this prior to ordering and we can provide stud layouts or customize the wall framing to allow for easy installation.

## 6.3 Plumbing Considerations



Often our garages are required to accommodate house pool change rooms, bathroom or bar sinks. Our garages are fitted with appropriate plumbing fixtures to provide modern convenience without losing rustic aesthetic.

Similar to main electrical feeds, let your Design Specialist know where you plan to install your plumbing main. We can provide stud layouts or customize the wall framing to allow for easy installation.

## 6.4 Interior Insulation

Enjoy your Summerwood garage for years to come by insulating your walls to make them moisture resistant. Here's how:

1. Use an R-rated insulation such as fiberglass.
2. Seal the insulation with a suitable vapor barrier such as polyethylene.
3. Finish with drywall or use cedar or pine to retain that "garage" feeling.

There are several ways you can finish your garage interior. Ask your local hardware representative for options.

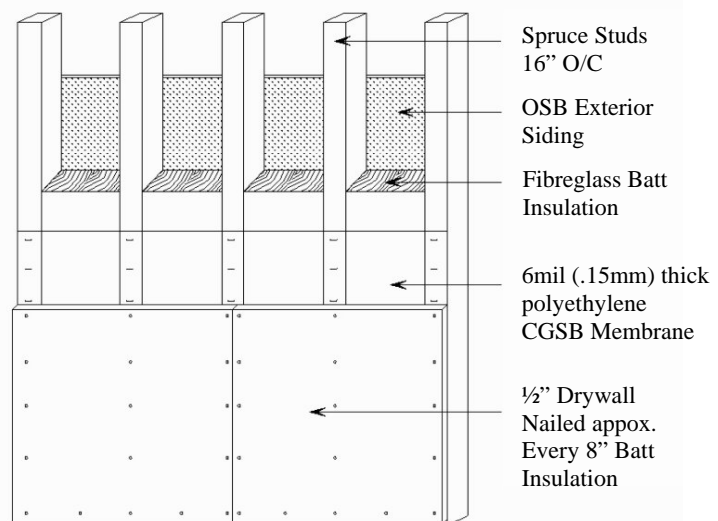

## *THANK YOU AND HAVE FUN!*

Thank you for taking the time to read this document. We hope you've found it very useful and informative. Should you have any additional questions on this, or any of our other products, please don't hesitate to contact us. Visit us online at [www.summerwood.com](http://www.summerwood.com) email us at [design@summerwood.com](mailto:design@summerwood.com) or call us at 1 800 663-5042. We're here to help.